

RUTHMANN
professionals at work

STEIGER® TB 270

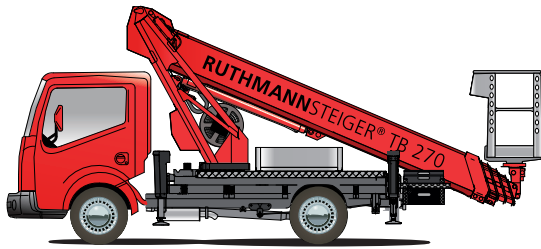

RUTHMANNSTEIGER® TB 270

Top performance through state-of-the-art technology.

- 27 m working height
- 14.8 m outreach
- 230 kg working cage load capacity
- diverse base vehicles > 3.5 t (GVW)*
- telescoping boom system made of heavy-duty fine grained steel and single-welded seam
- innovative "Truss Tower" turret
- 2 X 90° cage-rotation device
- working cage access door – climb up/down using convenient steps
- hydrostatic cage levelling
- time-tested horizontal/vertical jacking mechanism for maximum versatility
- total vehicle length: ≥ 6.75 m
- low vehicle height: ≥ 3 m
- safe positioning at inclinations 5°
- certified control-system technology with automatic set-up/retraction mechanism, memory-positioning system and many other innovative functions.

*gross vehicle weight



For further information visit: www.ruthmann.de/tb270en

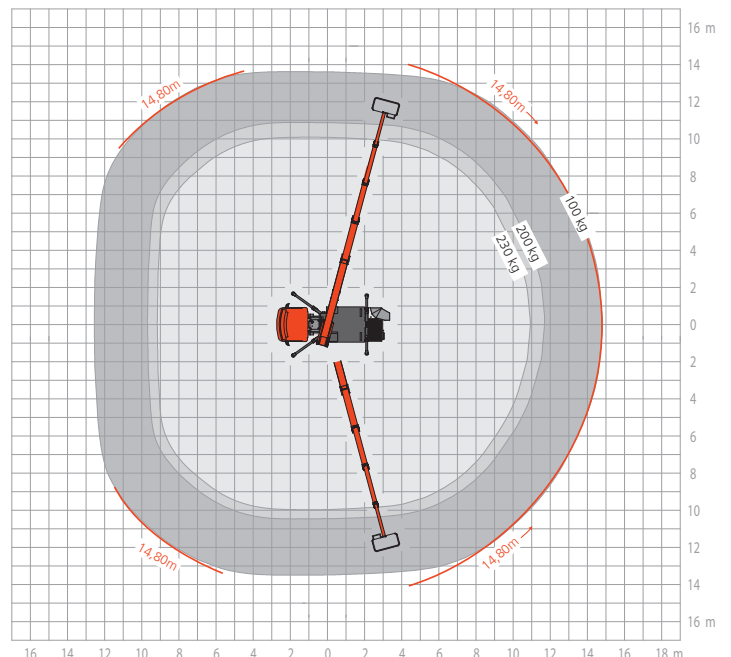
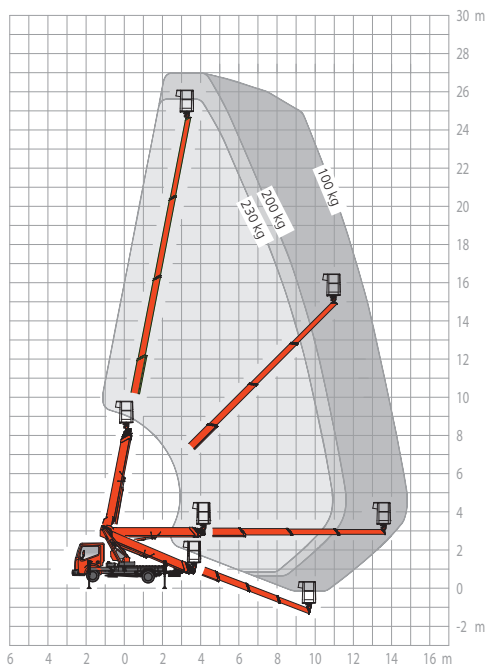

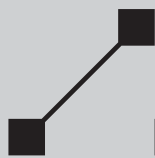

STEIGER® TB 270

The **RUTHMANNSTEIGER® TB 270** has taken over as the most efficient piece of machinery in the 3.5 t (GVW) truck-mounted aerial platform category. Its predecessor, the TB 220, was a huge company success. More than 500 models of this time-tested **STEIGER®** were sold.

The market-leading TB 270 features an impressive 27 m working height and 14.8 m outreach. The 230 kg load capacity of the working cage is 30 kg greater than the usual carrying capacity of cages in this class. Additional highlights include a boom system made of sturdy, fine-grained steel that is meticulously welded with a single, perfectly-centred seam.

The superior capabilities of the TB 270 are demonstrated in tough, daily assignments carried out by rental companies, municipalities, electric utility companies and tradesmen including painters, tree cutters, roofers, building cleaners, etc.

Additional highlights include: an innovative new cage rotation device enhanced to 2 X 90°, a turret called "Truss Tower" with

"space-frame design" (light-weight yet warp-resistant), a working cage which can be entered, loaded/unloaded using the convenient cage door/access steps and a hydrostatic cage-levelling device which assures ultra-smooth and easy cage adjustments.

Innovative new additions have greatly enhanced the excellent, time-tested features also found on previous models.

The automatic set-up/retraction mechanism, information/diagnostic system and the memory-positioning system (for easy piloting to the most recent operating position) are all standard features on the new TB 270.

Furthermore, this exciting new model has a total length of just ≥ 6.75 m, a width ≥ 2.1 m and is only ≥ 3 m high.













There are many base vehicles from which to choose including the 4-wheel drive variety. All-wheel drive vehicles not only offer plenty of load capacity but also have a smaller wheel base which makes driving in dense, inner-city traffic a lot easier.

The **RUTHMANNSTEIGER® TB 270** also comes with the time-tested horizontal/vertical jacking mechanism. Jacking is possible within the contours of the vehicle, on one side only or complete. The TB 270 can even be safely jacked on inclinations

of up to 5°. Lifting, rotation, telescoping, etc. can all be done simultaneously.

Contact us by phone, fax or email to find out more about the advantages, uses and service range of our proven and reliable **STEIGER®** models.



RUTHMANNSTEIGER®		TB 270	
	Working height	27,00 m	 Total length of vehicle \geq 6,75 m
	Lifting height	25,00 m	 Perm. siting inclination 5°
	Outreach	14,80 m	 Perm. total weight \geq 3.500 kg
	Size of working cage	1,40 x 0,70 m	 Range of rotation 450°
	Carrying capacity of working cage	230 kg	 Driving Licence B / 3
	Overall height \geq	3,00 m	 Wheelbase carrier chassis \geq 2,90 m