

STEIGER® TB 290

RUTHMANNSTEIGER® TB 290

The world's highest on 3.5 t

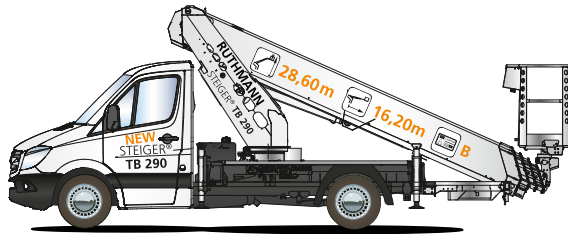

- 28.60 m working height even with 230 kg max. working basket load
- 16.20 m outreach with 100 kg working basket load
- max. performance data on EURO 6 chassis, 3.5 t zGG (permissible total weight) - driving licence class B
- Multi-sided profile boom technology of high-strength fine-grained steel with tower, which remains in the vehicle profile whilst it is swivelling
- sturdy basket rotating device 2 x 85°
- Horizontal / vertical support in steel design for variable jacking widths
- short total length of 6.94 m – 3.02 m total height
- new COCKPIT control with optional information and diagnosis display in the basket
- Automatic mode for retraction/ positioning and memory function for storing a position on the working object
- and much more



more informations: www.ruthmann.de/tb290

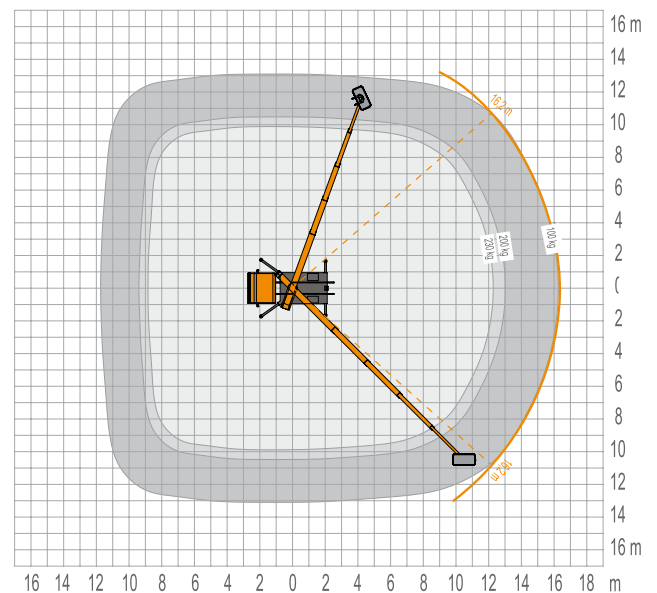
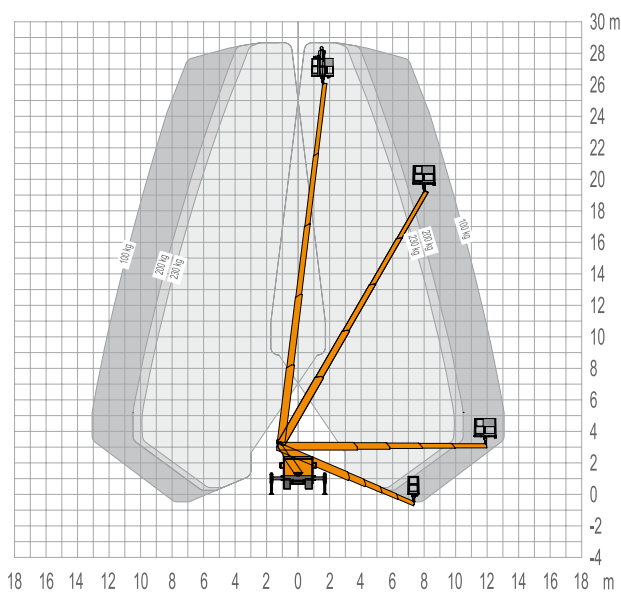

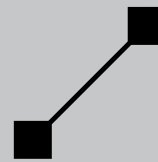

STEIGER® TB 290

The new **RUTHMANNSTEIGER® TB 290** onwards the world's highest truck-mounted aerial working platform on a 3.5 t chassis. It is the follow-up development of the so far top model STEIGER® TB 270+. It is still very easy in handling and naturally optimized for vehicles with EURO 6.

With the sensational working height of 28,6 m we offer to aerial working platform rental companies and end users like gardeners, landscapers, cleaning companies and craftsmen a 3.5 t truck-mounted aerial platform as an alternative in the 30 m class. Thanks to the STEIGER® TB 290, workspaces can now be reached which were previously only accessible from 7.49 t truck mounted aerial platforms.

The **RUTHMANN** steel construction and calculation expertise makes it possible. The further development of the STEIGER® TB 270+, which promises two meters more working height with the same outreach, is born of weight savings in the structural steel construction (optimized tower, telescopic boom and basic frame) and additional/ further 3° of the elevation angle of the telescopic system. The last mentioned feature does not only enable more working height. One can set up significantly closer to objects in order to reach the working position. This also reduces the space required for the supported STEIGER®.

230 kg basket load and the further solid maximum stability qualify the STEIGER® TB 290 for daily rugged use. Also, because the energy guiding chain is protected within the high-strength high-tech fine-grained steel boom which is multiple folded and has only one weld. And the multiple common parts guarantee a quick training/ briefing, simple operation and 'smart' spare parts inventory. The new STEIGER® TB 290 which has an inclination of up to 5°, can be set up and used in mountainous regions and non-traffic regions – under restricted performance data.

By the interchangeable basket system, you can exchange aluminium and plastic baskets within the current TB(R) classes at will, depending on what is needed. Operation under live lines up 1000 V is possible when the plastic basket is fixed. For electric and power supply companies, this is a 'must have'.













Chassis factor:
If the permissible total weight of the carrier vehicle is not important for you or your drivers, we can also put the STEIGER® TB 290 on

trucks of up to 6.5 t GVW. This brings much more payload and possibly more durability. Regardless if with or without all wheel drive, but always with EURO 6.

Contact us. Simply by phone, fax or E-mail. We are happy to inform you about the services of our STEIGER® and will point out the benefits for you!



RUTHMANNSTEIGER® TB 290

	Working height	28.60 m		Total length	6.94 m
	Lifting height	26.60 m		perm. siting inclination	5°**
	Lateral outreach	16.20 m*		Perm. total weight	3,500 kg
	Working cage size	1.40 x 0.70 m		Range of rotation	450°
	Working cage capacity	230 kg		Wheelbase carrier chassis	2.90 m
	Overall height	3.02 m		Driving Licence	B

* depending on load, angle of rotation and outfit
** with restriction of performance data

All measurements and weights are approximate and refer to the standard basic execution. Technical alterations reserved. **STEIGER®**, **GELENKSTEIGER®**, **RÜSSEL®** and **CARGOLOADER®** are registered trademarks of **RUTHMANN GmbH & Co. KG**

Ruthmann GmbH & Co. KG
von-Braun-Str. 4 - 48712 Gescher-Hochmoor - GERMANY
Fon: +49 2863 204-0 - Fax: +49 2863 204-212
Internet: www.ruthmann.de - E-Mail: export@ruthmann.de